

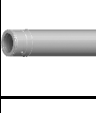









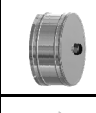
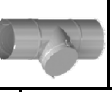
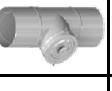





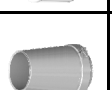
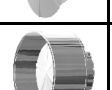
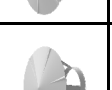



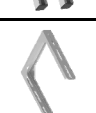

## Bestellformular NiroLine DW 25/50

<b>Firma:</b>	Name:			Unterschrift:
<b>Tel. Nr.:</b>	Kommission:			Stempel:
<b>Liefertermin:</b>	Lieferart: <input type="radio"/> Normal (bis 18 Uhr) <input type="radio"/> Mittags (gegen Aufpreis) <input type="radio"/>			
<b>Lieferadresse:</b>				
<b>Tel. Aviso</b>				

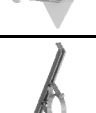
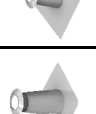
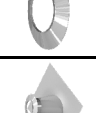
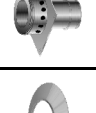
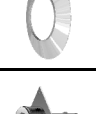
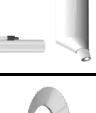
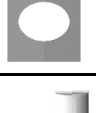
GP UD	Einzelteile:	DN:	DW 25:	DW 50:	Längenelement	Längenelement	Längenausgl.-element	Längen- element	Reinig.öff. m.Feder. UD 600° C	Reinig.öff. Quetschd. UD/ÜD 200°	Reinig.öff. m.sichtb.D. UD 600° C	Reinig.öff. m.sichtb.D. UD/ÜD 200°	Reinig.öff. mi Kugelf. UD
Art.: 84 ... 11						950 mm	0 84 ... 449	0 84 ... 49	84 ... 275	84 ... 276	84 ... 375	84 ... 376	84 ... 273
Stk.:					450 mm	84 ... 450	84 ... 890	84 ... 49	84 ... 275	84 ... 276	84 ... 375	84 ... 376	
					200 mm	84 ... 200							

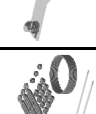
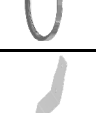
GP UD	Ob.Stat. Reing.öff. m.stat.Kle. UD 84 ... 277	Ob.Stat. Reing.öff. m.sichtb.D. UD 84 ... 377	T-Stück m. Reing.öff. gegenü.RR 84 ... 278	T-Stück 90° 84...170	Anschluss- teil für wb. Ofenanschl. 84 ... 172	Übergang z.Einst. von.Ofenr. 84 ... 8	Klemm- band statisch 86 ... 18	Abström- konus 84 ... 36	Deflektor- haube 84 ... 35	Regen- haube für LE 84 ... 34	Regen- haube mit Funkenflug. 84 ... 37	Bogen 90° mit Rev. 90° UD 84 ... 264	Bogen 90° mit Rev. 90° UD 84 ... 265
Art.Nr.: 84 ... 12													
Stk.:													

Konsol- blechpaar 65 mm WA 86...140	Wandkonsole aus Prof. Konsolenlänge o 350 / o 500 / o 620 o 750 / o 820 o 1030 / o 1120	Wandbef. 50 mm WA 86 ... 006	Wandbef. verstellbar m.2.Bügel 86 ... 008	Verlänger. für Wandb. WA ... mm 86 ...	Profilver- längerung für Wandb. 86000...	Sparren- halter 86 ... 34	XL-Flach- Dachdurchf. inkl.Regenk. mit Hochzug 86 ... 195	Dachdurchf. inkl. Regenk. mit Hochzug 86 ...	Regen- kragen mit Hochzug 86 ... 180	NiroEnd für LBS 845 ...	Wand- rosette 86 ... 182	Silikon 86913 Gleitn. 86000091	Blendblech 86 ... 181 Aufpr.ellipt. 86100	Abspannung 86 ... 30 Abspannset 8600080	Dach- hakenset 3 Stk. 8600081	Dichtung bis 200° C Überdruck 86 ... 049
																
Stk.:																





**Sonstige Bemerkungen:**

---

**Tel.: +43 512 28 88 81 Fax.: +43 512 28 88 81 - 10 Mail: bestellung@stocker-kaminsysteme.com**

## Bestellformular NiroLine DW 25/50

Firma:	Name:	Unterschrift:
Tel. Nr.:	Kommission:	Stempel:
Lieferttermin:	Lieferart: <b>Normal</b> (bis 18 Uhr) o <b>Mittags</b> (gegen Aufpreis) o	
Lieferadresse:		
Tel. Aviso:		

Einzelteile:		DN:	DW 25: o	DW 50: o	
<b>Bild</b>					
<b>Text</b>	Beheizbares Fußteil mit Kondensatablauf	Kürzbares Längenelement statisch lang (nur für Unterdruck)	Kürzbares Längenelement statisch kurz (nur für Unterdruck)	Längenausgleichselement 300 - 450 mm kürzbar (nur für Unterdruck)	Längenausgleichselement 510 - 890 mm kürzbar (nur für Unterdruck)
<b>Art.Nr.:</b>	84 ... 148	84 ... 520	84 ... 310	84 ... 449	84 ... 890
<b>Stk.:</b>					
					Deckel für T-Stück für Außen
					T-Stück für Zugregler
					86 ... 132
					84 ... 172

Sonstige Bemerkungen: